



INTELLIGENT E-BUSINESS
SOLUTIONS

COMPANY PROFILE

www.intelligent-ebusiness.com



Table of contents

About us	2-3
Our products	4-5
Network and IT Support Services	6-7
Application Development	8-9
Design and Creativity	10-11
Vehicle Tracking Solutions	12-13
Sewage and drainage CCTV survey service	14-15
Install & Maintain Telephone Exchange	16-17
Install & Maintain Fire Alarm System	18-19
Install & Maintain CCTV System	20-21
Intelligent Electronics Team	22-23
Solar Electricity Solutions	24-25
Manufacturing Variable Message Sign	26-27

QUALITY AND CUSTOMER SATISFACTION IS OUR GOAL



**INTELLIGENT E-BUSINESS
SOLUTIONS**

Customer satisfaction is a top priority in any competitive business. But for Intelligent Solutions it is merely the point of departure. Within Intelligent Solutions, operational excellence means maximizing our customers' satisfaction, our market position and financial results by ensuring continual quality and cost improvement in our processes, products, and services. Deployment of our quality and customer satisfaction strategies enables us to meet the commitments within our quality policy.

IEBS Quality Policy

- Actively ensure that our customers' requirements and needs are identified and incorporated into our solutions.
- Ensure that quality is included at all points in our research, development and delivery processes.
- Strive to provide a superior product, service and solution to our customers.
- Always keep in mind that the only reason for Intelligent Solutions existence is to meet our customers' needs.

Meeting and exceeding customer expectations is vital to our success. Our customer expectation and satisfaction management program is a key element within our policy. We use a proactive approach to ensure that

customers' expectations are understood, communicated throughout the organization, and met with timely, practical and innovative solutions. Our goal is to continuously improve our customers' satisfaction and experience with IEBS.

Intelligent Solutions commitment to customer satisfaction has been strongly embedded in the company values since creation and it became the cornerstone of the Intelligent Solutions quality management culture. Customers drive our business strategies toward achieving success and excellence in everything we do, and will continue to be our key focus for developing products and services that accelerate their capability to prosper in their business.

So our goal is to ensure that everyone in our company is customer focused and that we maintain the highest standards of customer service and satisfaction that we can, relative to the resources at our disposal. We are committed to compliance with requirements that relate to our business. We will set and review objectives and targets to ensure continual improvement in our management system.

OUR PRODUCTS

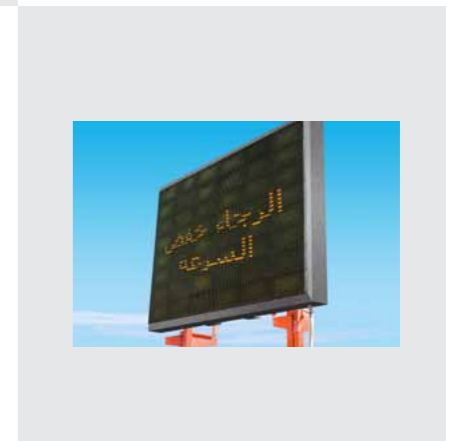
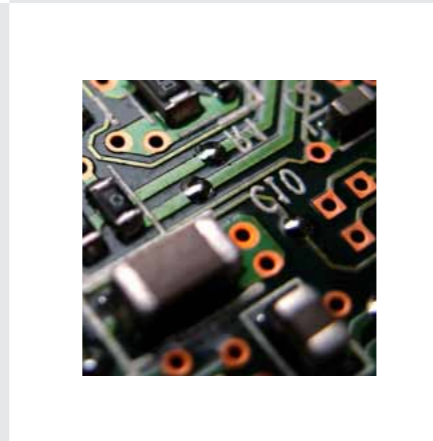
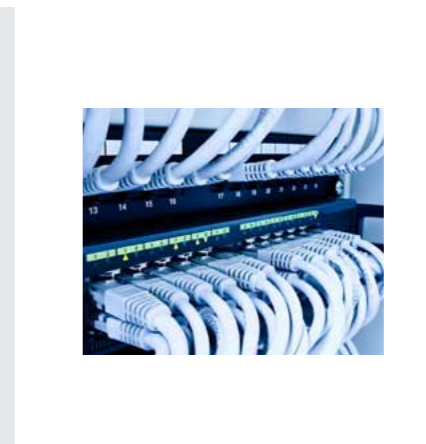
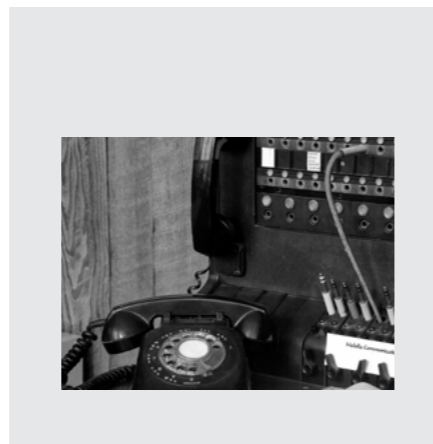

NETWORK AND IT SUPPORT SERVICES

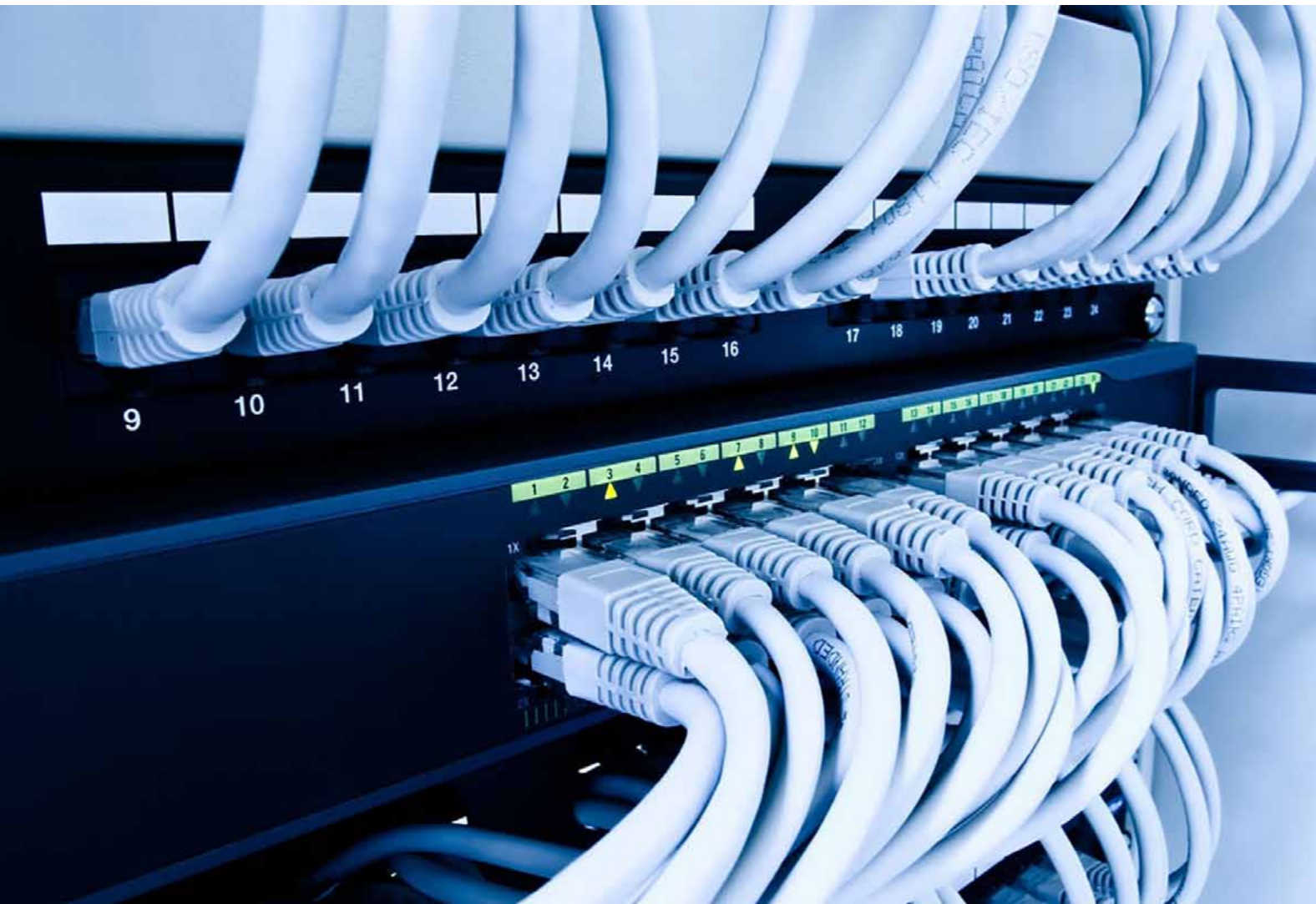

The information systems and technologies are essential part of success for each company. These systems can enhance the performance of its sales, management and store.

Our network and IT support team, with its qualified member's offers you 24 hours support for your network and IT infrastructure. At Intelligent Solutions we design network and full IT infrastructure to fulfil your needs and give you high performance network speed and quality. We offer local area network, wireless network and fibre optic networks.

We also offer a range of IT products including laptops, desktops, servers, switches, applications and others.

Our IT support team is currently supporting more than 18 companies for their PCs, servers, PBX, Biometric devices, printers, routers

and other device. We offer yearly contracts and per visit charges. The support includes software support as well as hardware.

As security is one of the key features we focus on, we offer security auditing services for your organisation. This includes recommendation about best practices for your IT team and end users.

Intelligent solutions offer intelligent backup solutions for your local and remote offices to make sure you have backup of user's files for easy recovery when it get corrupted or lost.

APPLICATION DEVELOPMENT



Since the start of the company, Intelligent Solutions worked on developing its partner companies IT infrastructure. This includes developing business specific applications to digitise the operations. Hence, we developed several applications using the latest technologies and security methods and ensured the quality and reliability of the programs.

At Intelligent Solutions we focused on developing web based applications for easy access and compatibility.

Our Applications:

- 1. Heavy Equipment Hiring applications:** for hiring generators, excavators, loaders and other heavy vehicles. It includes: booking system, quotations, customers, machines management, fuel management as well as full accounting and reporting system.
- 2. HR software:** for full HR management, employee details and profiles, intelligent indications for visa, passport, CPR and other data expiry. Online document management.
- 3. Attendance software:** for managing employee attendance and salary generation.
- 4. Fuel Management software:** for light and heavy vehicles, full management over fuel, oil and status maintenance. Indication reports on abnormal consumption.
- 5. Travel Management Software:** for managing booking for hotels, flights, buses and packages. It includes full accounting software.

DESIGN AND CREATIVITY



The launch of a new company requires an overall theme which includes logo, stationary, signboard, advert, and a profile. The theme gives the first impression about the company. Hence, Intelligent E-Business Solutions launched a design and creativity department to fulfil its customer needs.

The company employed creative designers with long design and printing work experience from different sections. The focus on delivering high quality designs for customers, has led us to make day to day reviews of the designs before delivering them.

As a start, we focused on our partner companies needs such as the design and print of letterheads, stamps, envelopes and others. Then we began our journey in designing logos and profiles.

Services:

1. Design of logos, stationary, signboards, profiles, adverts, calendars, magazines and others.
2. Stationary printing at competitive prices.
3. Photography service for events and locations.

Projects:

1. **Logos and full Stationary:** Universal Asphalt, Single Point Heavy Lifting, Single Point Aluminium, Single Point Carpentry, Alferdos, Universal Hydraulics, Universal Manpower and Intelligent E-Business Solutions.
2. **Profiles:** Grand Tiger for Mechanical and Industrial, Sayed Kadhem Aldurazi & Sons, Universal Asphalt, Universal Real Estates.
3. **Calendars:** Magenta Laundry, Almustafa Kindergarten.



VEHICLE TRACKING SOLUTIONS



Partnering with a Finnish company, Intelligent Solutions offer it customer with vehicle tracking solutions. Nowadays, it is essential for each company to have tracking solution for its vehicles. This helps the companies to satisfy customers and reduce fuel costs by managing vehicle routes.

The solution we offer has 24 months warranty, allow live tracking, easy and interactive history play back, fuel tracking, geo-fencing and speed reporting. It has many reports which allow customers to have accurate results. The solution comes with desktop and web versions to monitor the vehicles.

At Intelligent Solutions we offer the customers either to buy or rent the devices. This reduces the cost for customers with fleet of vehicles.

Our customers using this solution for different kinds of vehicles, including: ready mix mixers, pumps, cranes, small cars, six wheels, buses and pickups. So far our technicians installed more than 500 devices for different companies.

Our service and support continues and covers all aspects including training for the end users and making new special reports for customers with large fleet.

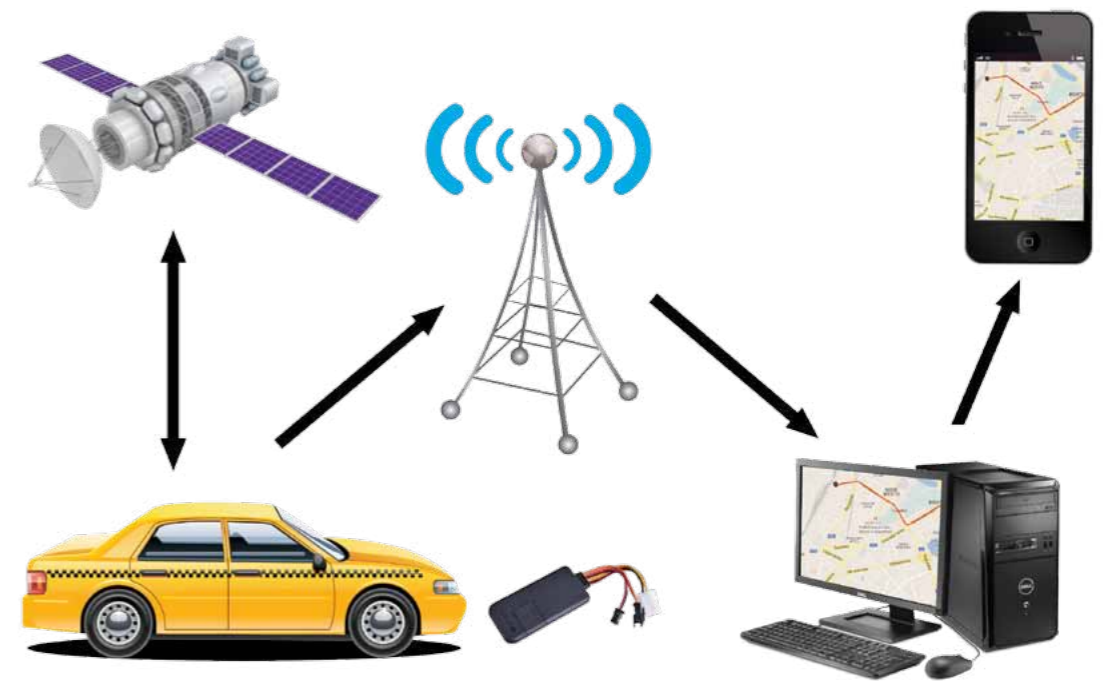

SEWAGE AND DRAINAGE CCTV SURVEY SERVICE



Using the best in the market, and the latest crawling machine, Intelligent E-Business Solutions got expertise in the field of sewage and drainage pipeline inspection. Our team has been fully trained and certified by the manufacturer of the world best crawler.

Unlike other service providers who use old and used machines; we are the first company to get the IPEK RX130 crawler in the gulf. Our Machine has very high resolution camera which can work under the water, has a laser technology and high storage. We can perform inspection of pipes from 100 up to 2000mm diameter.

Our scope of work includes mechanized clearing of the pipes and then CCTV Survey. The team gives instant reporting to the project manager for any leakage, cracks or other issues to speed the maintenance.

We have successfully done pipe inspection for drainage and sewage in several areas of Bahrain, including Tubli, Busaiteen and Investment gate Bahrain. We did more than 15000 meters so far.

INSTALL & MAINTAIN TELEPHONE EXCHANGE



Panasonic

AVAYA

Using the latest telecommunications technologies, Intelligent Business Solutions offers phone exchange systems to its customers. Our expertise allows us to design a solution which meets your current and future requirements. Our engineers have the experience to implement the solutions for fixed and remote offices with high quality voice calls.

Since the establishment of the company, we focused on improving the services for the customers and upgrading their existing pbx systems to the latest ones.

At Intelligent Solutions we mainly offer Avaya and Panasonic PBX which are the best stable

systems in the market. We offer analogue and digital solutions including SIP.

Projects and customers:

1. Sayed Kadhemi Aldurazi and Sons; Avaya PBX, more than 50 extensions, multiple incoming lines, IP and SIP phones.
2. Trust Travel ; Avaya PBX, multiple incoming lines, multiple extensions.
3. Alhaidariya Heavy Equipment hiring; Nortef, 12 lines
4. Universal Hydrolics; Panasonic, PBX, 3 lines
5. Universal Foundations; Panasonic, PBX, 4 lines
6. Universal Readymix ; Panasonic, PBX, 4 lines

INSTALL & MAINTAIN FIRE ALARM SYSTEM

Since its establishment, Intelligent Solutions specialised in Fire Alarm System. Fire Alarm systems are being used in all kind of residential, commercial and industrial buildings and workshops.

The company employed qualified engineers and technicians to fulfil this need and meet

the civil defence of Bahrain standards and requirements. Both conventional and addressable fire alarm system are being provided by the company.

Our engineers are fully capable to: design, implement and make maintenance for fire alarm systems. Our expertise allowed us to



recommend best brands to use for different customers and to give best solution.

In order to achieve fully responsive system, we perform regular pro-active maintenance and testing of our customers' existing systems.

Some of our customers and Projects are:

1. Sayed Kadhem Aldurazi & Sons offices: All offices, workshops and garage: regular maintenance.
2. Universal Real Estates Buildings: design, implementation and maintenance.
3. Eker Camp(Labors camp, 4 buildings more than 200 rooms): design, implementation and maintenance.
4. Gulf Insurance company (Addressable): design, implementation.

And many others.

INSTALL & MAINTAIN CCTV SYSTEM



At Intelligent Solutions, we spotted the need for fully functioning CCTV system for home and business security. Hence, we worked to enhance the security of our clients by providing CCTV camera system.

The main focus is to design a system which can detect any kind of theft or security hazard, putting the security cameras in the best locations to spot such acts. We make sure the customer has 24 hours recording, day and night vision, using indoor and outdoor Cameras. Our services include: design, implementation, testing, adjustment and maintenance.

We provide the customer with the option to monitor his office or site remotely, either from his PC or mobile. We also provide different Brands and resolutions (Full HD, 1050p, 720TVL and others).

For contract customers, Intelligent Solutions do pro-active maintenance for the camera's and the recording. We give the customer to choose between 24 hours recording or motion detection recording.

Projects and customers:

- 1. Grand Tiger:** design, implementation of more than 60 cameras.
- 2. Investment Gate Bahrain (Gate):** 24 hours recording CCTV working on Solar Power.
- 3. Residential Compound:** 2 residential compounds for customers.

And many others.



INTELLIGENT ELECTRONICS TEAM



Our long experience electronic maintenance team is fully capable to repair any electronic circuits.

Intelligent Solutions is recognized by its customers of offering fast and reliable diagnostics and repairing for electronic circuits.

Intelligent Solutions scope of work starts with diagnostic of the problem, customer awareness of the work needed and after approval starting the maintenance of the item. We specialized in large and small electronics and managed to repair: crane computers, man lifts boards, scissor lift boards, computers, phones, PBXs, different kind of controllers and boards.

The company since its starts has been maintaining ready mix concrete plants, Ice Plants, sand washing plants, welding machines, generator and other kind of plants and machineries for its customers.

The maintenance service which we provide has saving thousands of money for our customers by repairing the defected parts and not having to charge the circuits or get it repaired outside the country.

Our team has designed 3 Reverse osmosis Plants control system as well as doing the implementation of these designs and future modifications as per the customer needs.

The company offers on site visits for plants and large machineries as well as offering our services at out workshops.



SOLAR ELECTRICITY SOLUTIONS



Having independent and green energy source would cut a lot of costs on consumers. Hence, Intelligent E-Business Solutions solar division is providing this solution for customers.

The company provides customized solution as per customer needs and available space. Our qualified engineers make sure the customer gets as much as possible from the solar power. To achieve this we make recommendations on best practices and types of devices being used.

The customer is being introduced to our systems and design before starting the

implementation. In which give the choice of having night solution or only during sun lights solutions and we make sure the customer has the advantages and back draws of both.

We offer solutions for houses and buildings as addition to the normal electricity suppliers. It can work together and shift from one to other. This can cut some of the cost on the customers.

Currently we provide 3000 Watts solutions which can be expandable to the user needs.

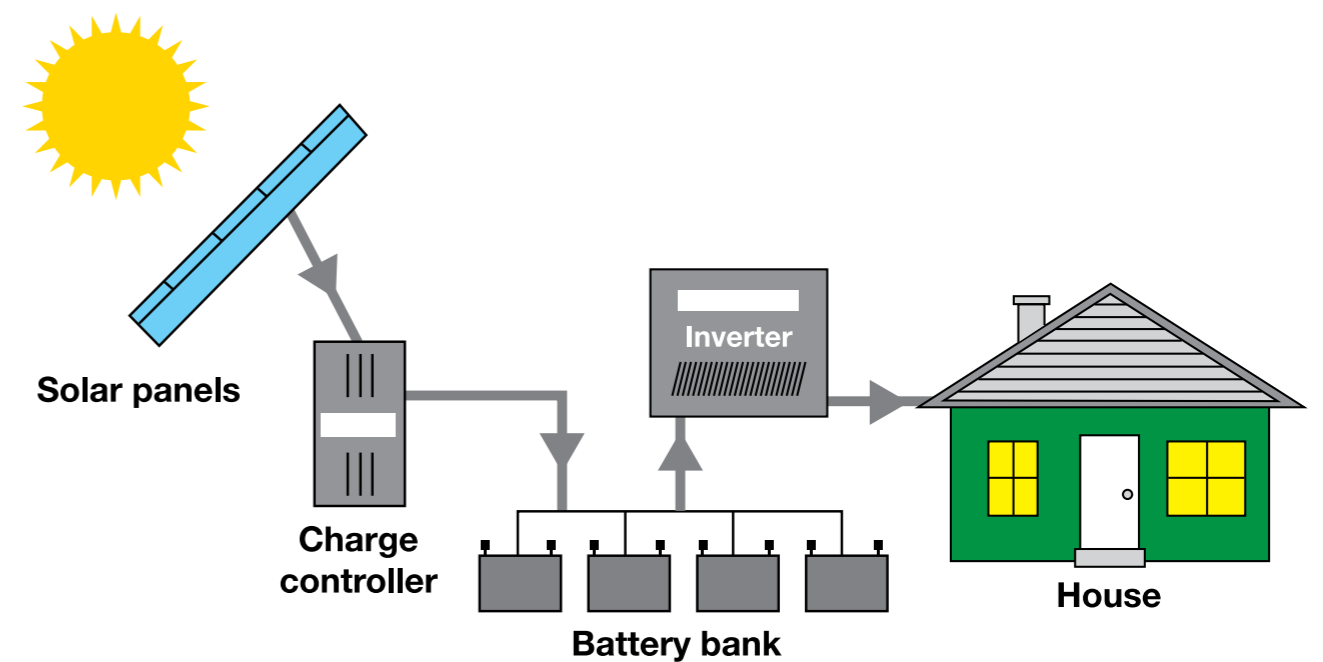

MANUFACTURING VARIABLE MESSAGE SIGN



Road VMS Features:

- Height 1 – 1.2 Meter
- Widths 2 Meter
- Working Hour 24 Hours
- Backup battery 18 hours
- Programming through RJ45.
- Solar charging
- Alternative AC charging

Variable Message Signs are being manufactured at our location in Bahrain. The idea started in 2014 as the team was reviewing how to supply it for a special customer.

Since then, the design and manufacturing of the first VMS taken place. The testing of the first prototype in the field has enhanced the quality and performance of our next generation VMS.

Our current variable message signs work 24 hours in the roads of Bahrain and being charged via Solar power without the need

of alternative power supply, but we supply alternative charging solutions as per the Ministry of Works requirements.

We produce high quality VMS which is suitable for use in different weather conditions for competitive prices in Bahrain. We also offer customization for our design to meet your needs.

Intelligent Solutions also offers VMS for advertising purposes for shops and roads, one color, 3 colors or full colors.



Professional website design



INSTALL & MAINTAIN CCTV SYSTEM



Fingerprint Attendance System



Install & Maintain Fire Alarm System



IT Support Services



Serving you at your office and home.

Car Tracking System



For more information
WWW.INTELLIGENT-EBUSINESS.COM

P.O.Box: 2996 - Manama, Kingdom of Bahrain
Tel: +973 17 622 868, Fax: +973 17 621 727
E-mail: info@intelligent-ebusiness.com
WEB: www.intelligent-ebusiness.com